



U-Prox PIR Combi

Wireless motion and glass break sensor,
insensitive to animals

Table of contents

Table of contents.....	2
Introduction	3
Security warnings	3
Applications for customization.....	3
U-Prox Installer mobile application.....	3
Installer web portal.....	3
Description and principle of operation.....	4
Functional elements of the device.....	4
Features	4
Power supply	5
Display in the current mode	5
Installation	6
Selecting the installation location.....	6
Installation	7
Turning on and off	7
Settings.....	9
Adding a device to the security system (registration).....	9
Basic settings of U-Prox PIR Combi	11
Testing the connection	18
Remove a device	21
Wireless device states	22
Service.....	23
Replacing the battery	23
Compliance with standards	23
Warranty obligations.....	23
The scope of delivery	23

Introduction

This manual describes how to install and configure the U-Prox PIR Combi wireless pet-sensitive glass motion and break sensors. Please read this manual carefully before using the device.

Technical support for all U-Prox products is provided by phone: +38(091)481-01-69 and/or e-mail: support@u-prox.systems.

Security warnings

WARNING. THE APPLIANCE HAS A BUILT-IN BATTERY. SUBSTITUTING AN INCORRECT TYPE OF BATTERY FOR THE APPLIANCE MAY RESULT IN A FIRE OR EXPLOSION. DISPOSE OF USED BATTERIES IN ACCORDANCE WITH LOCAL LAWS AND REGULATIONS.

Applications for customization

U-Prox Installer mobile application

Application for setting up the U-Prox wireless security system.

It is intended for both individual users and engineers of central monitoring stations.

Using a mobile phone, the app allows you to perform full security system setup: install, test, and calibrate wireless system elements; configure security groups; connect to monitoring stations; add users and give them the right to control the security system from the U-Prox Home app.



Installer web portal

The U-Prox Installer WEB web portal is designed to configure the U-Prox wireless security system.

It is intended for both individual users and engineers of central monitoring stations of security organizations.

Using a web browser, you can perform full configuration of the security system: install, test, and calibrate wireless system elements; configure security groups; connect to monitoring stations; add users and grant them the right to control the security system from the U-Prox Home app.

<https://web-security.u-prox.systems/>



Description and principle of operation

U-Prox PIR Combi is a combined digital passive infrared and acoustic radio channel sensor equipped with a PIR sensor and a microphone, designed to protect closed residential and industrial premises, glazed structures, windows, etc.

Based on changes in the thermal balance of the environment or the sound of glass breaking, it sends a signal of intrusion to the U-Prox alarm center.

The sensor is equipped with a special lens and is intended for use in rooms where pets (cats, dogs, etc.) may be present.

The device is insensitive to the movement of animals weighing up to 20 kg.

The acoustic data is processed according to an algorithm that analyzes the sequence: a dull impact and the ringing sound of falling glass fragments.

It is installed indoors.

The sensor works only with the U-Prox security system; it cannot be connected to third-party systems.

Functional elements of the device

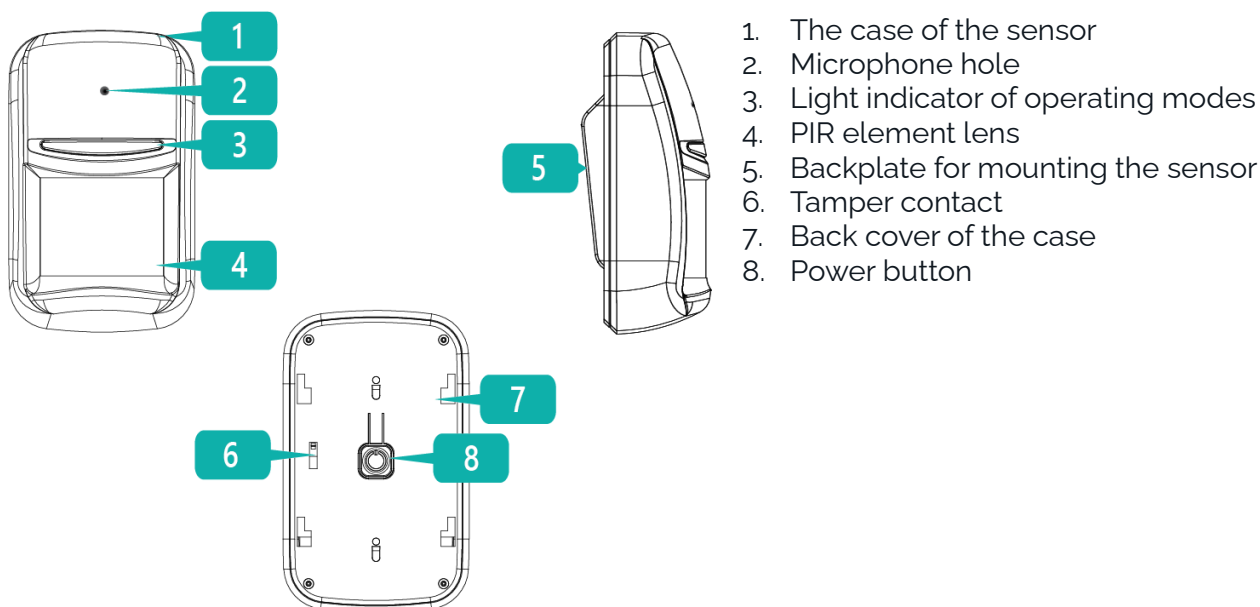

1. The case of the sensor
2. Microphone hole
3. Light indicator of operating modes
4. PIR element lens
5. Backplate for mounting the sensor
6. Tamper contact
7. Back cover of the case
8. Power button

Features

Motion sensor	
Sensing distance	12 m

Detection angle	88°
Target speed	0.3 ... 3 m/s
Optical noise immunity	no less 6500 Lux
Insensitivity to animals	movement of animals weighing up to 20 kg
Glass break sensor	
Maximal range	8 m
Detection angle	120°
Types of glass	Plain, patterned, tempered, laminated, reinforced, protected by polymer film of A1, A2, A3 classes, 4x16x4 double-glazed windows
Glass thickness	2 mm ... 8 mm
Glass dimension	0.5 m x 0.5 m ... 3.0 m x 3.0 m
Power supply	3V, CR123A lithium battery included
Service life of a battery	up to 5 years
Radio communication	ISM wireless interface with multiple channels
Radio communication parameters	ITU region 1 (EU, UA): 868.0...868.6 MHz, 100 kHz bandwidth, 20 mW max., distance to devices - up to 4800 m (outdoors); ITU region 3 (AU): 916.5...917 MHz, 100 kHz bandwidth, 20 mW max, distance to devices - up to 4800 m (in open space).
Data transmission (radio)	Two-way communication, encrypted, with sabotage (jamming) detection. The encryption key is 256 bits
Operating temperature range	-10°C ... +55°C
Permissible humidity	Up to 75%
Climate class	II (EN 50131)
Sensor dimensions	90 x 60 x 34.35 mm
with wall backplate	90 x 60 x 41.6 mm
with corner backplate	90 x 60 x 48.84 mm
Case color	white, black
Weight	150 grams

Power supply

The device uses a CR123A lithium battery, which allows it to operate for up to 5 years on a single battery.

Display in the current mode

The light indicator shows data transmission and sensor triggering. Data exchange with the security center, LEDs light up sequentially:

1. Sensor triggering - red
2. Data transmission:
 - Green - transmission is successful
 - Red - data transfer failed
3. Receiving confirmation
 - Green - reception is successful
 - Red - data reception failed

Steps 2 and 3 can be repeated up to 3 times (transmission repeats with increased power)



Installation

Selecting the installation location

Choose the installation location of the U-Prox PIR Combi device carefully, taking into account the direction of the lens, microphone, and any obstacles that may limit the sensor's view.

The sensor should be installed in such a way that the area of the most likely glass breakage or intrusion is located in the sensor's maximum field of view and the direction of the intruder's movement is perpendicular to the installation axis.

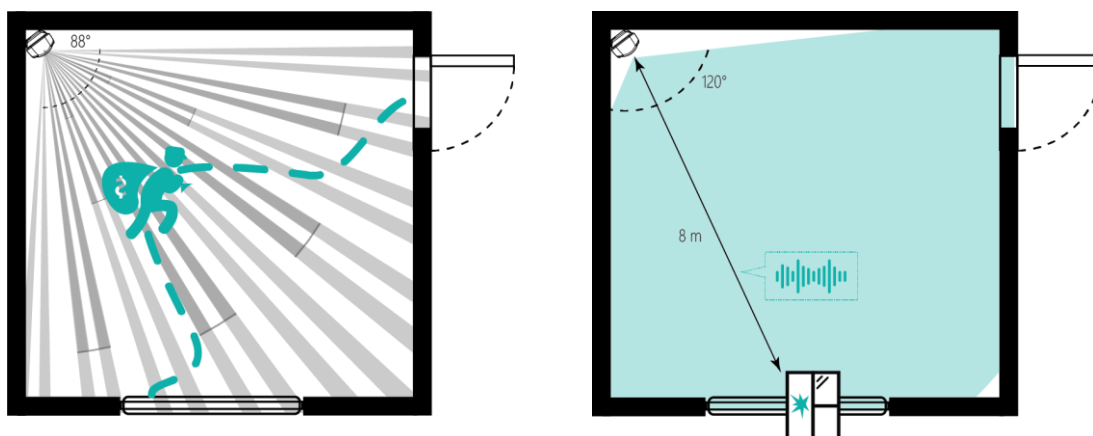

To maximize the sensor's viewing area, install it at a height of 2.1 meters from the floor level.

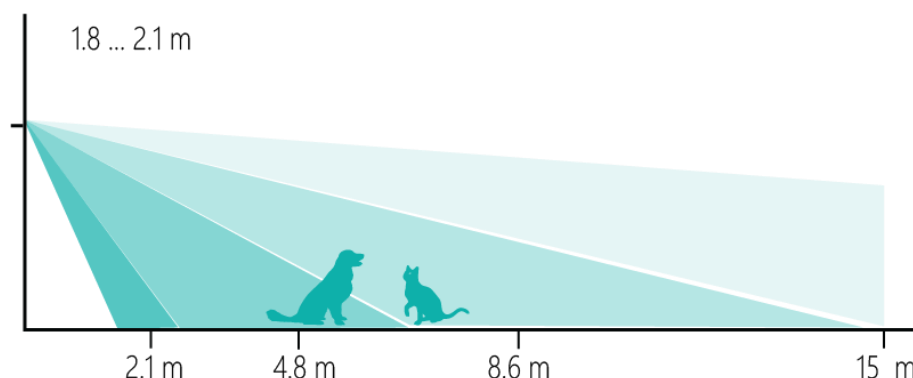

The appliance must not be placed:

1. Outdoors or in rooms with unacceptable humidity and temperature
2. In places with a high level of radio interference
3. Near objects that can cause attenuation or shielding of the radio signal (metal, mirrors, etc.)
4. In such a way that direct sunlight hits the sensor lens
5. Opposite objects with rapidly changing temperatures or in places with rapid air circulation
6. Opposite moving objects with the human case temperature
7. At a distance closer than 1 m from the security center

It is recommended to perform the installation in the following sequence:

1. Registering the sensor in the security system using the U-Prox Installer app
2. Select the installation location with the optimal signal using the U-Prox Installer app. Please note that the sensor can be placed either vertically or horizontally
3. Installing the backplate (4)
4. Installing the device (1)

Installation

1. Two backplates are included - one for angled installation of the device and one for flat installation of the device
2. Mount the desired type of backplate (4) using the screws and dowels provided.

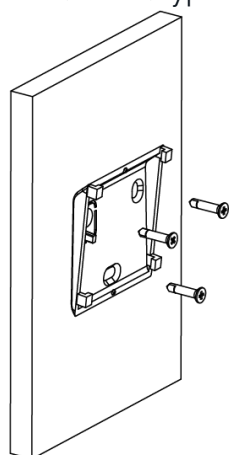

For a flat surface

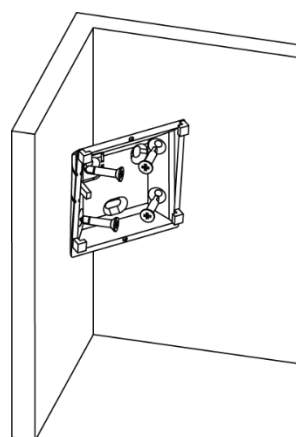

Corner backplate

3. Place the device on the backplate and slide it downward to engage and lock the tamper contact (5). Flashes on the indicator light (2) will confirm that the tamper is locked.

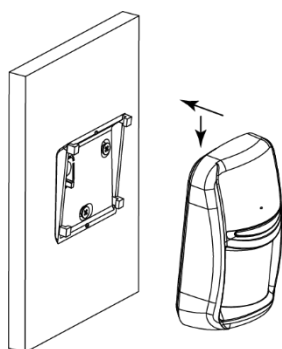

For a flat surface

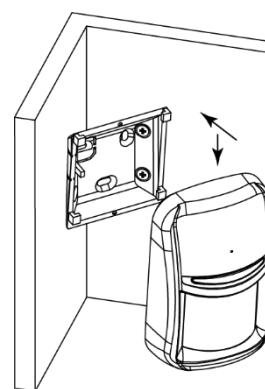

Corner backplate

WARNING! WHEN THE DEVICE IS INSTALLED CORRECTLY, THE TAMPER WILL BE CLAMPED (LOCKED).

Turning on and off

Press and hold the button  (8) for 3 seconds to turn on the device - the indicator light will be on.

If the device has already been registered in the security system, it switches to the standby mode.

To turn off the device, press and hold the button (8) for 5 seconds until the light indication goes out.

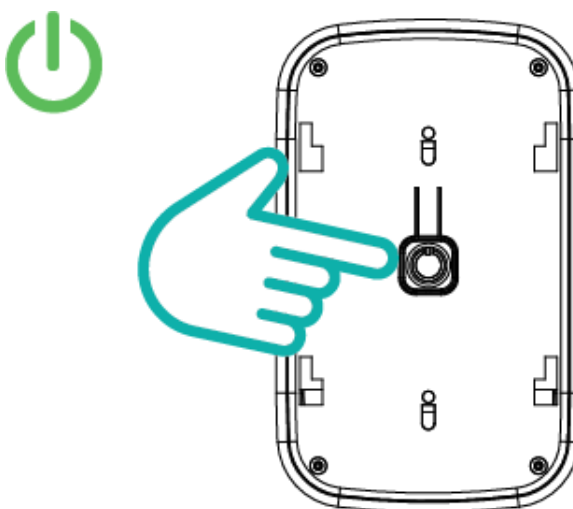

WARNING. IF THE DEVICE HAS NOT BEEN REGISTERED, IT WILL GO INTO SLEEP MODE AFTER 30 SECONDS.

Settings

1. Download and install the U-Prox Installer mobile application to configure the system
2. Launch the U-Prox Installer application and log in or log in using the U-Prox Installer WEB portal

IF NECESSARY, REGISTER IN THE SYSTEM AS AN AUTONOMOUS INSTALLER OR GET ACCESS AS AN INSTALLER OF A SECURITY COMPANY

Adding a device to the security system (registration)

1. Launch the U-Prox Installer application or open the web portal in a browser and log in

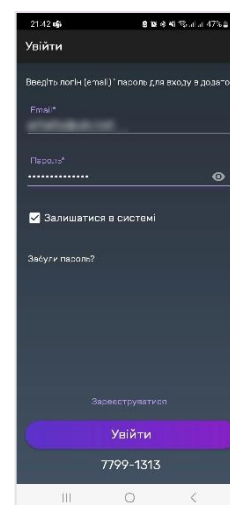
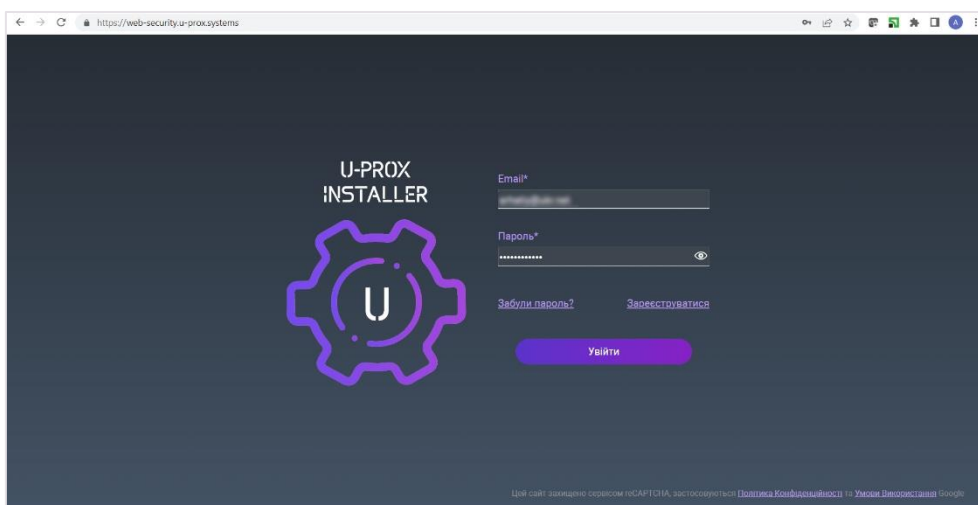

2. Select the U-Prox MPX to which you want to add the wireless sensor from the list of devices

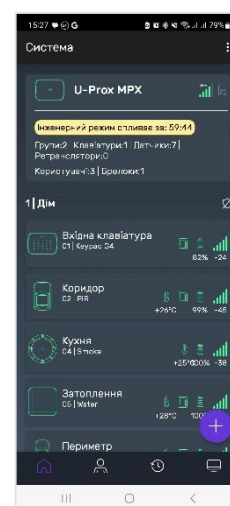
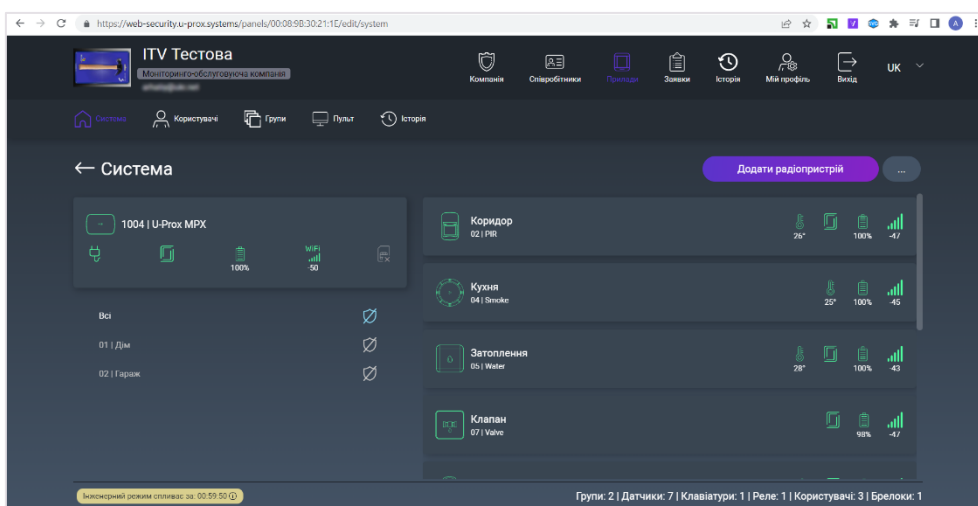

- Press the button (+) ("Add radio device"), the security center enters the mode of registering sensors, keypads, etc. In this window, you can click on the device icons and view the instructions for activation.

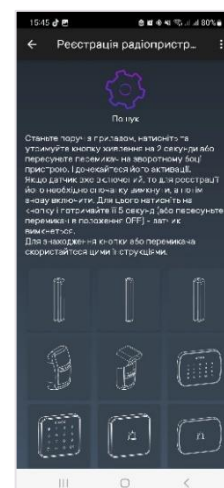
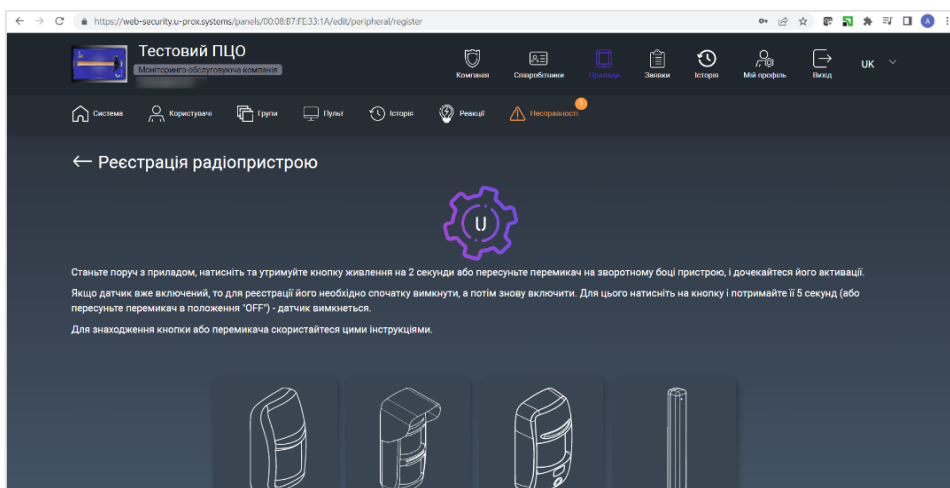

- According to the instructions, turn on the wireless sensor and bring it to the security center at a distance of about 1 meter

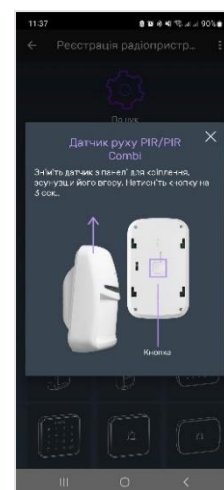
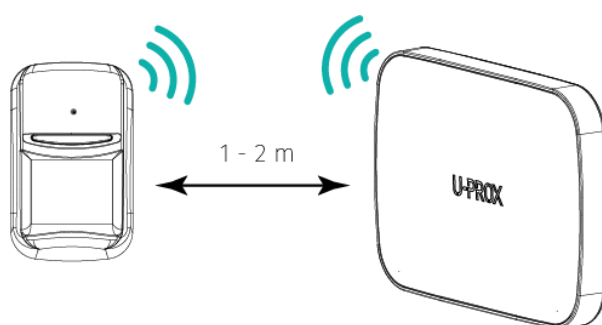

- Wait 15-20 seconds for the wireless sensor to be registered.
WARNING. THE DEVICE OPERATES IN TWO ADJACENT SECURITY ZONES. IN YOUR CONTROL PANEL SOFTWARE, YOU NEED TO CONFIGURE THE FIRST OF THESE ZONES AS "MOTION" AND THE SECOND AS "GLASS BREAK".

- The app will open the settings of the wireless sensor

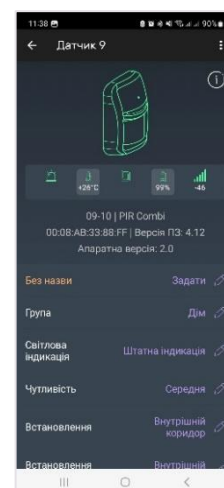
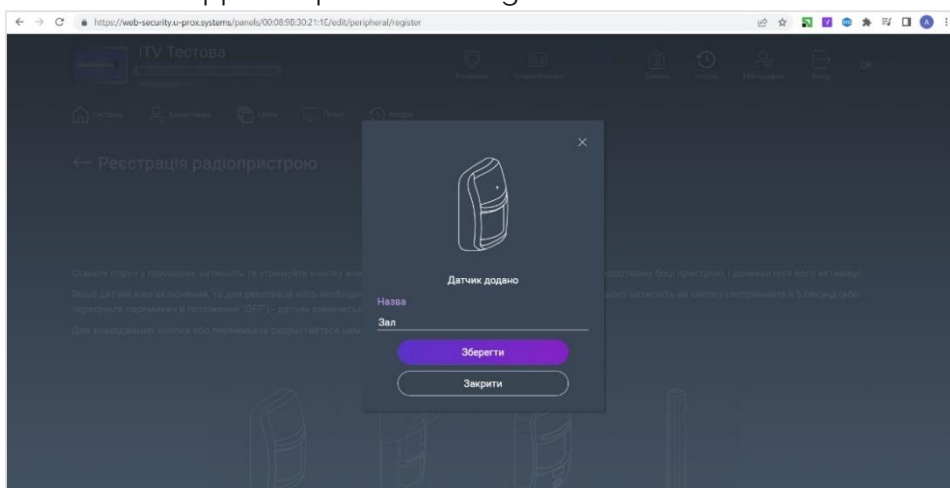

- Configure your device

Basic settings of U-Prox PIR Combi

Select the device you want to configure from the device list

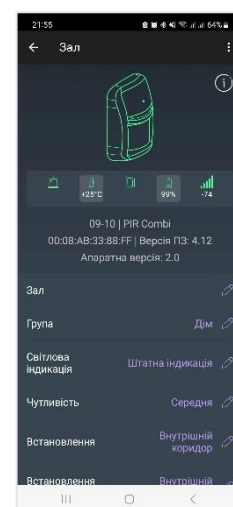
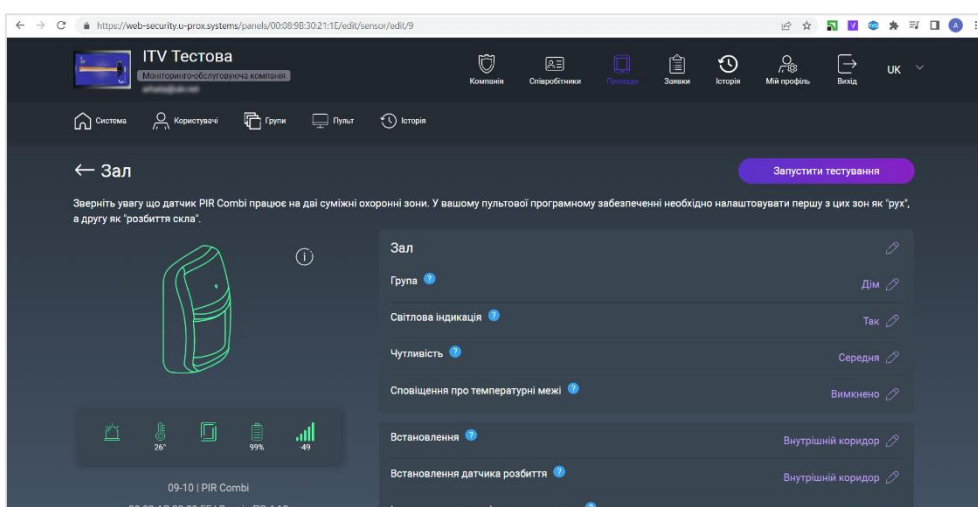

1. "Name" - the name of the device

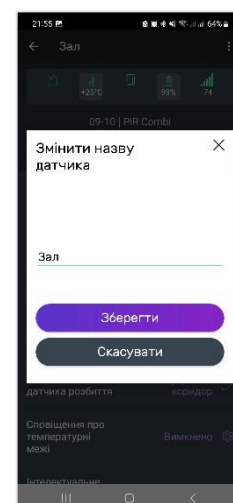
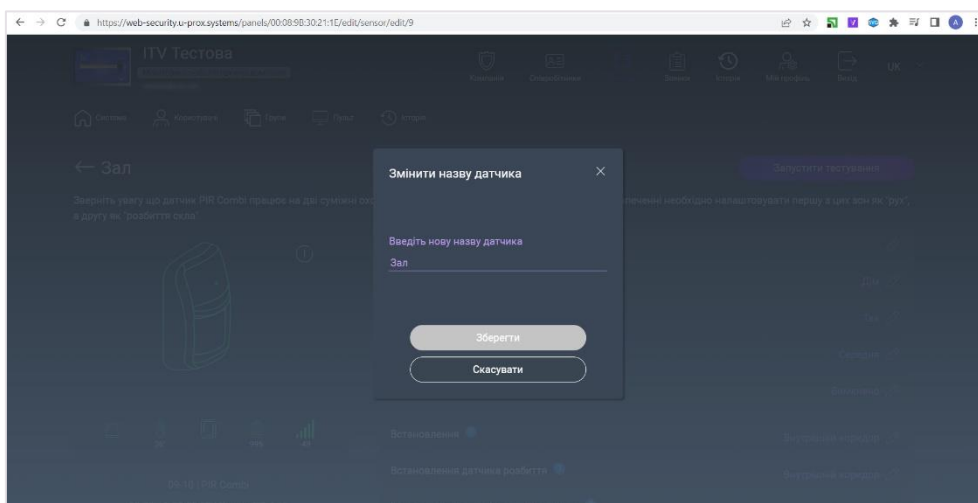

2. « Group » - selects the security group to which the device belongs.

A security group is a logical set of zones of a protected premises (for example, a room, apartment, garage, floor of a building, etc.), a minimum security unit. A security group allows you to manage all zones simultaneously. Security groups are independent - the user can manage and view only those security groups, devices, and events in them to which he or she has been granted access.

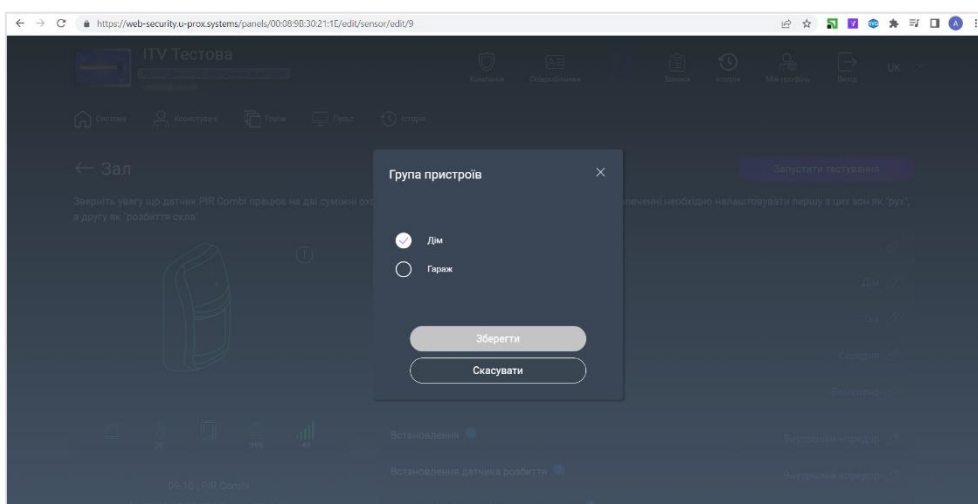

- "Sensitivity" - setting the motion detection range of the sensor. Low is about 6 meters, Medium is about 8 meters, and High is about 12 meters.

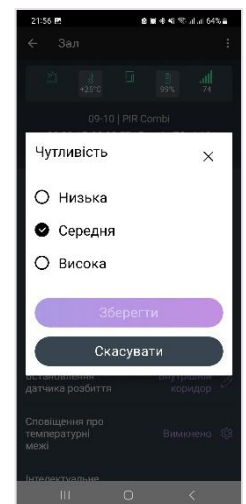
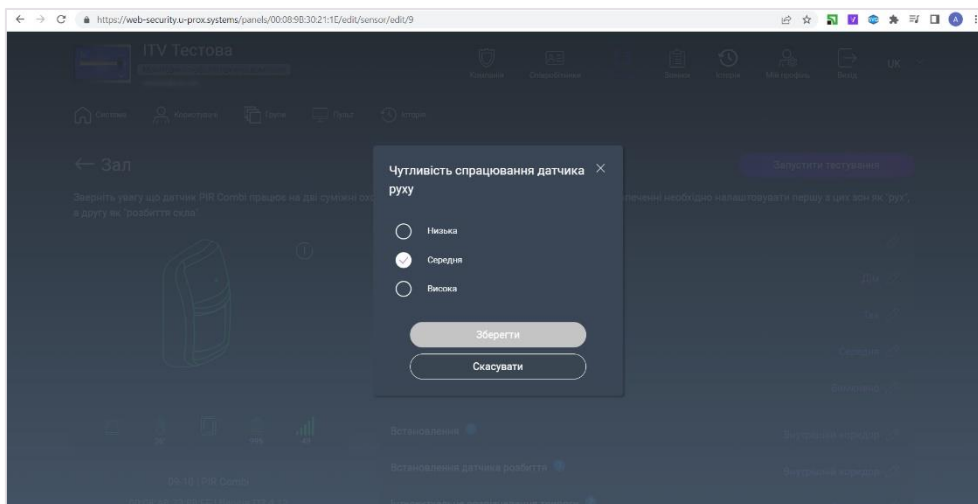

- "Light indication" - turns on or off the light indication on the device

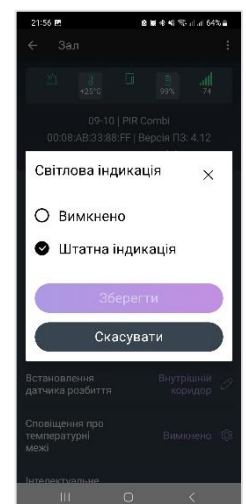
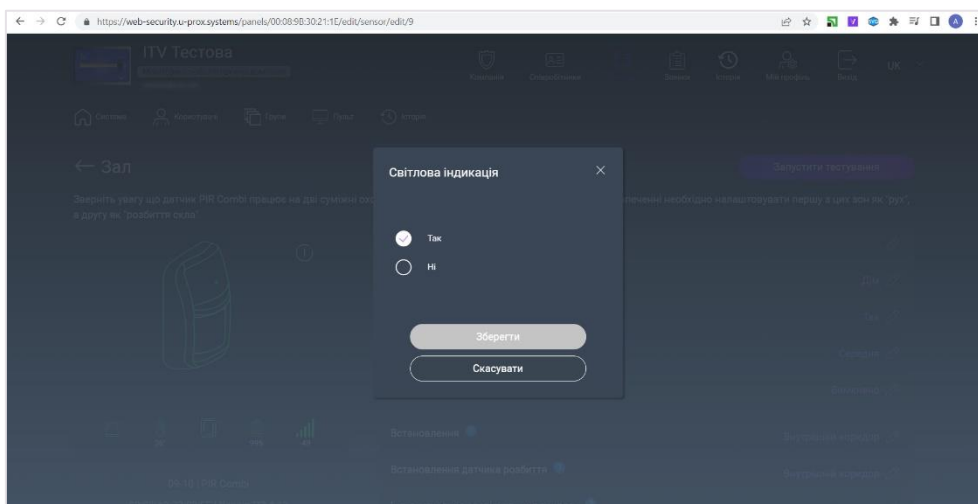

- "Temperature limits notification" - when the device exceeds the specified temperature limits, it will generate the corresponding events - "Cooling" and "Overheating". Can be used in scenarios

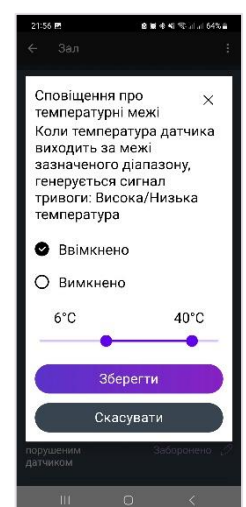
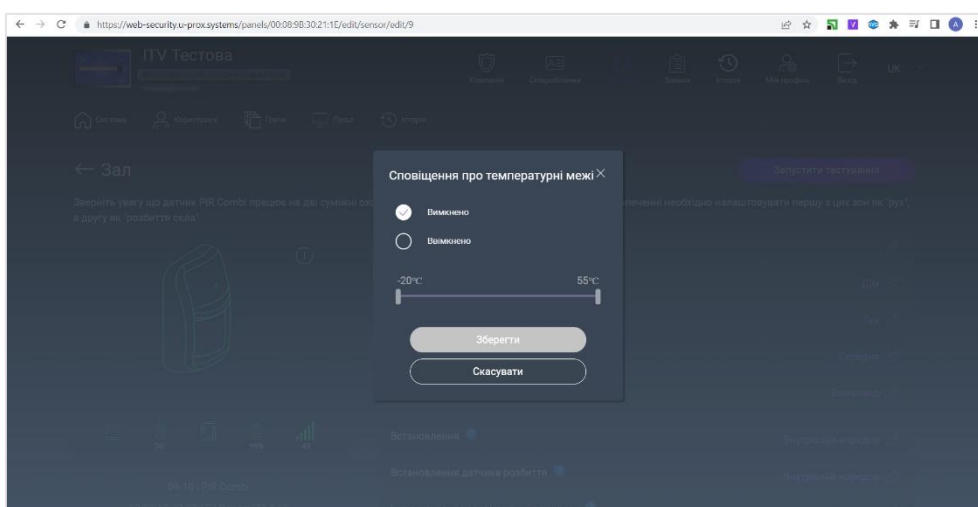

6. "Setting" (zone type for the motion sensor, PIR) - device operating modes depending on the type of use

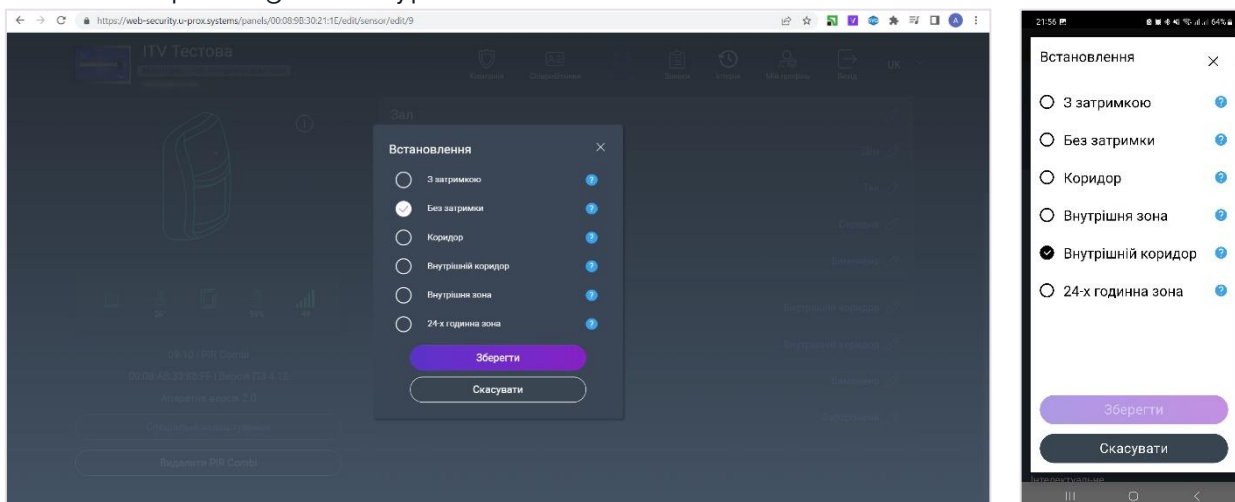

7. "Setting the break sensor" (zone type) - device operating modes depending on the type of use

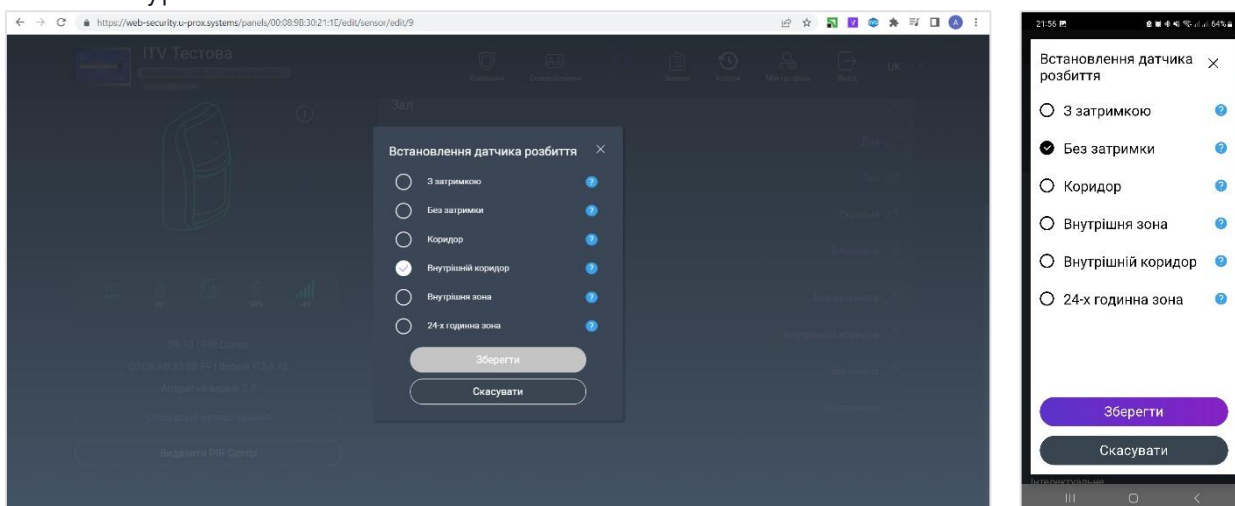

- a. "Delayed" or "Entrance zone":
 - if the system is armed, the entry delay starts when the sensor is triggered. If the system is not disarmed during the delay, the system switches to the Alarm state and sends an alarm notification
 - When arming, the exit delay will start counting down, after which the system will be armed.
- b. Without delay
 - if the system is armed, when the sensor is triggered, the system switches to the Alarm state and transmits an alarm notification
 - if the system is disarmed, the system does not respond to sensor triggering with this type of
- c. Corridor
 - if the system is armed and there is no entry delay or the delay time has expired, the system switches to the Alarm status and transmits an alarm notification
 - if the system is armed and there is an entry delay, the system does not respond to sensor triggering of this type
 - if the system is disarmed and there is a delay in exit - the system does not respond to the triggering of a sensor of this type

- if the system is disarmed, the system does not respond to the triggering of a sensor of this type
- d. Internal corridor
- if the system is armed and there is no entry delay or the delay time has expired, the system switches to the Alarm status and transmits an alarm notification
 - if the system is armed and there is an entry delay, the system does not respond to sensor triggering of this type
 - if the system is disarmed and there is a delay in exit - the system does not respond to the triggering of a sensor of this type
 - if the system is armed in the Perimeter mode ("Staying" or "Night mode") - the system does not respond to the triggering of a sensor of this type
 - if the system is disarmed, the system does not respond to the triggering of a sensor of this type
- e. Inner zone
- if the system is armed, when the sensor is triggered, the system switches to the Alarm state and transmits an alarm notification
 - if the system is armed in the Perimeter mode ("Stay" or "Night mode"), the system does not respond to sensor triggering of this type
 - if the system is disarmed, the system does not respond to the triggering of a sensor of this type
- f. 24-hour zone (around the clock)
- when the sensor is triggered, the system switches to the "Alarm" state and transmits an alarm notification in any system mode
8. "Delayed entry (only for the Delayed installation type). Time to disarm (disarm) the security system after entering the premises.

ONLY FOR THE DELAYED INSTALLATION TYPE ("INPUT ZONE")

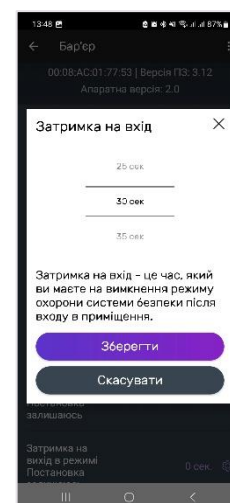
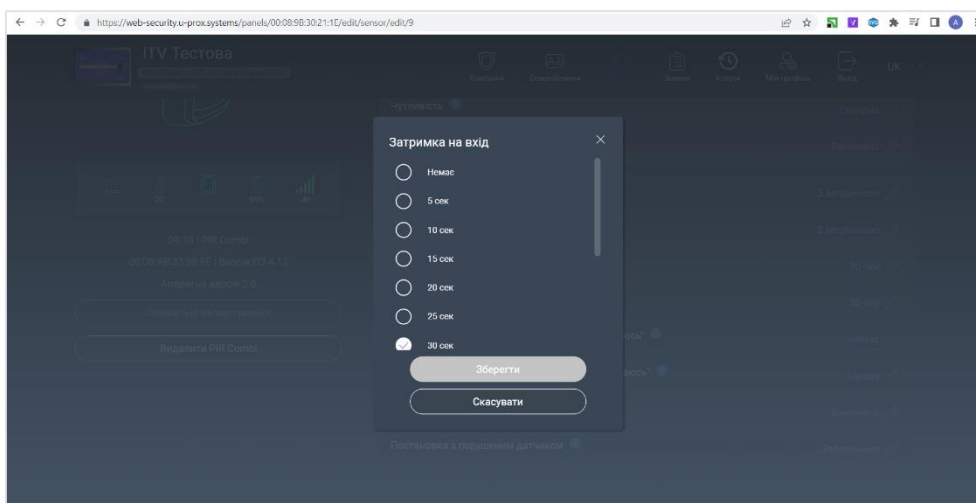

9. "Delayed exit (only for the Delayed arming type). The time to leave the premises after arming or disarming.

ONLY FOR THE DELAYED INSTALLATION TYPE ("INPUT ZONE")

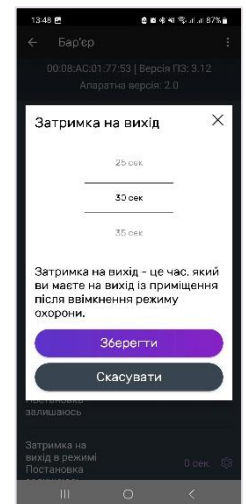
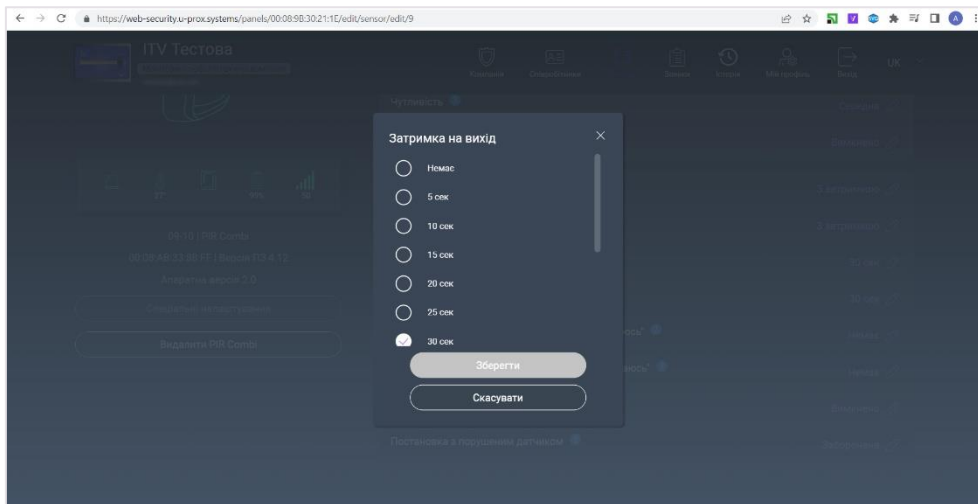

- "Delay for entry in Stay Armed mode" (only for the Delayed arming type). Time for disarming (disarming) the security system after entering the premises (arming in Stay, Night mode)

ONLY FOR THE DELAYED INSTALLATION TYPE ("INPUT ZONE")

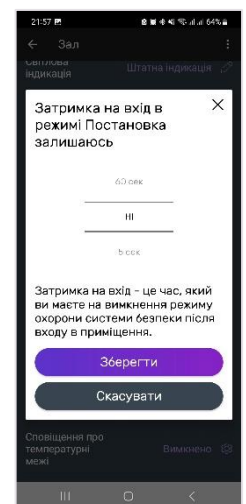
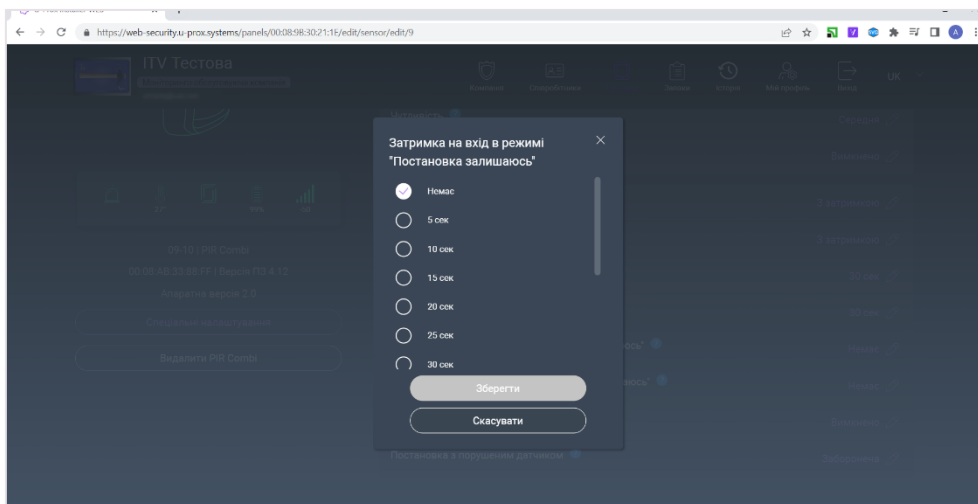

- "Delay to exit in Stay Armed mode" (only for the arming type - "Delayed"). Time to exit the premises after arming the Perimeter security mode (Stay, Night mode).

ONLY FOR THE DELAYED INSTALLATION TYPE ("INPUT ZONE")

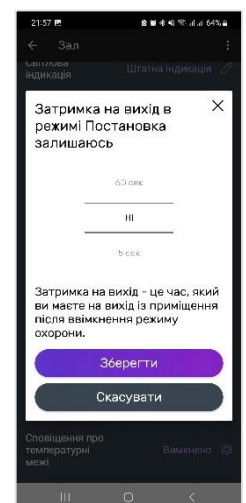
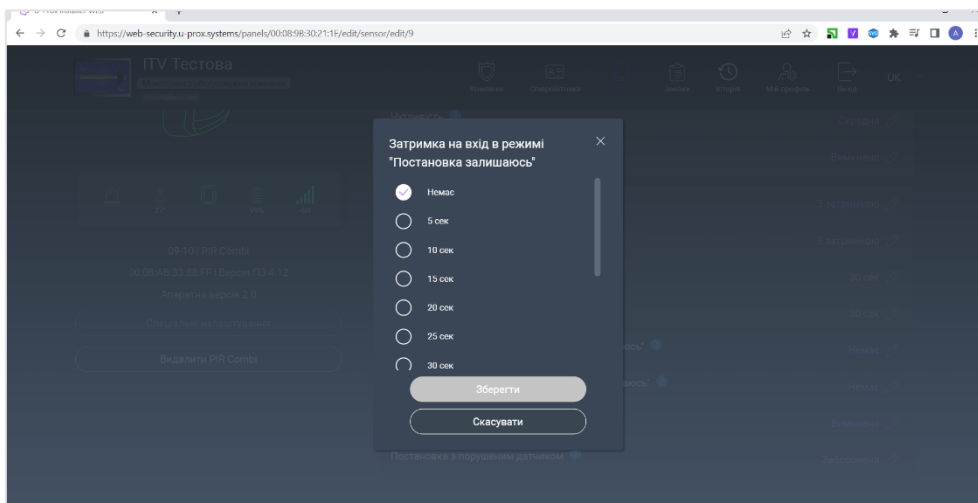

12. "Intelligent Alarm Recognition". When this setting is enabled, the motion sensors (U-Prox PIR, U-Prox PIR VB, U-Prox PIR Combi, U-Prox PIR Combi VB, U-Prox PIR Outdoor) of this security group are combined into a single "smart zone" with the alarm confirmation function.

When one of the sensors in the smart zone is triggered, a delay starts counting - 20 seconds by default. If during this time the Alarm condition occurs for any sensor within this group, or a repeated Alarm condition occurs for the same sensor, or the sensor remains in the Alarm condition until the smart zone delay expires, an alarm signal will be transmitted to the security company.

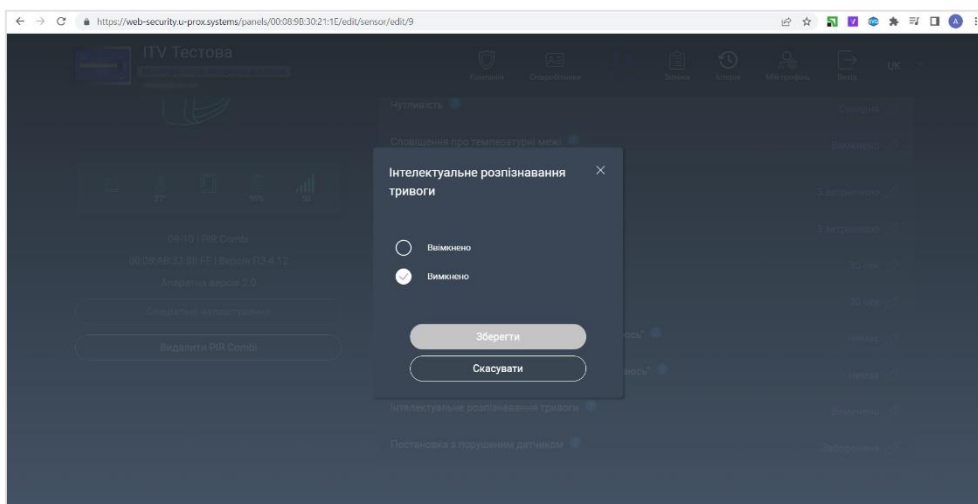

13. "Arming with a broken sensor" - forced arming of a sensor, even if it is broken
 - "Forced arming after exit delay" - if the sensor does not recover after the exit delay countdown, the system switches to the Alarm status and transmits an alarm notification
 - "Forced arming when the sensor is restored" - the system waits for the sensor to be restored and switches it to the Armed mode

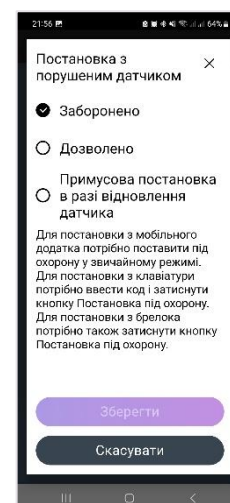
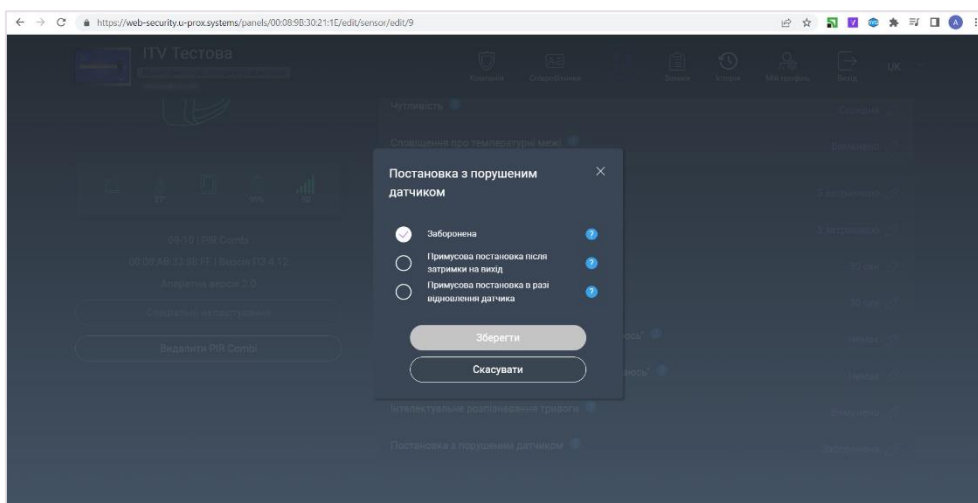

14. Special settings
 - "Disable tamper" - a setting when enabled, the device will not respond to the opening of the case
 - "Disable alarm when communication is lost" - do not generate an alarm when communication with the device is lost

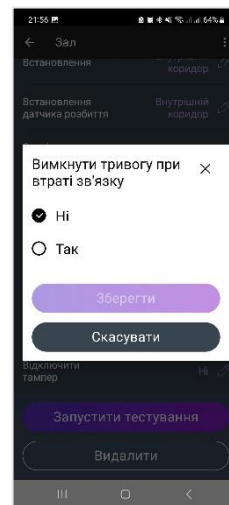
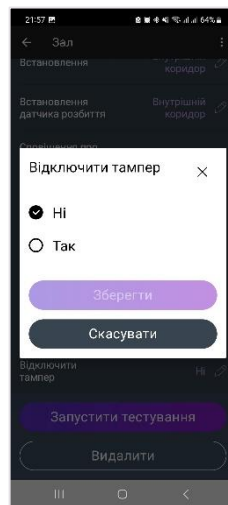
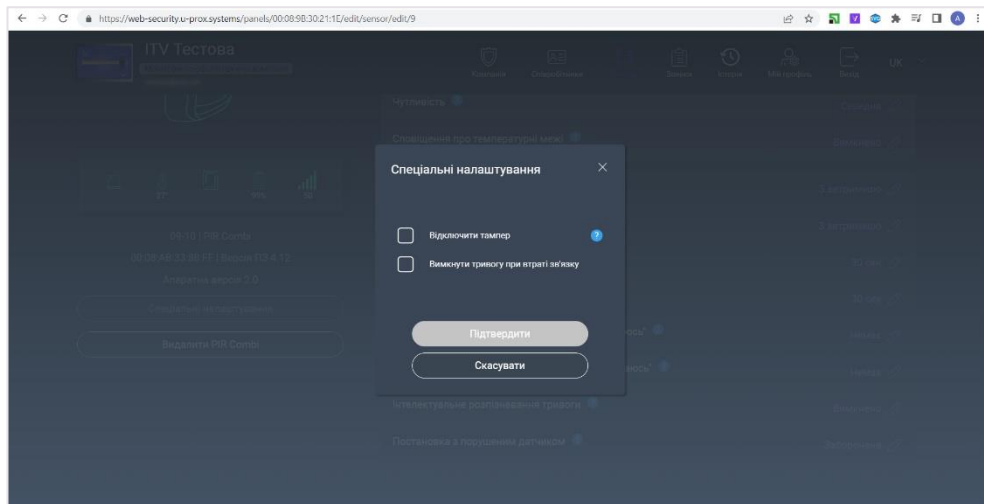

Testing the connection

WARNING. BEFORE PERFORMING THIS STEP, THE DEVICE MUST BE REGISTERED IN THE UPROX SECURITY SYSTEM.

1. Launch the U-Prox Installer application or log in to the U-Prox Installer WEB portal

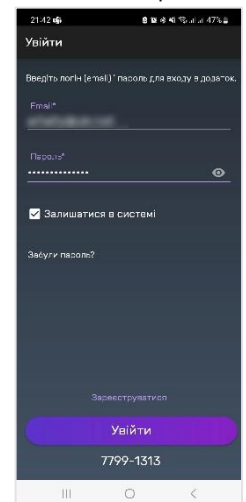
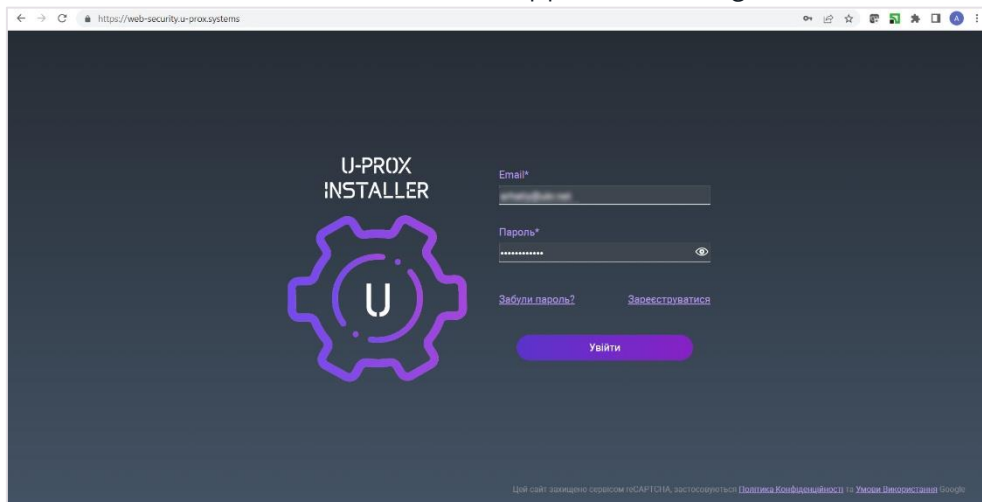

2. Select a security center from the list

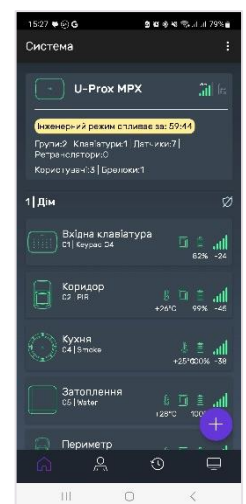
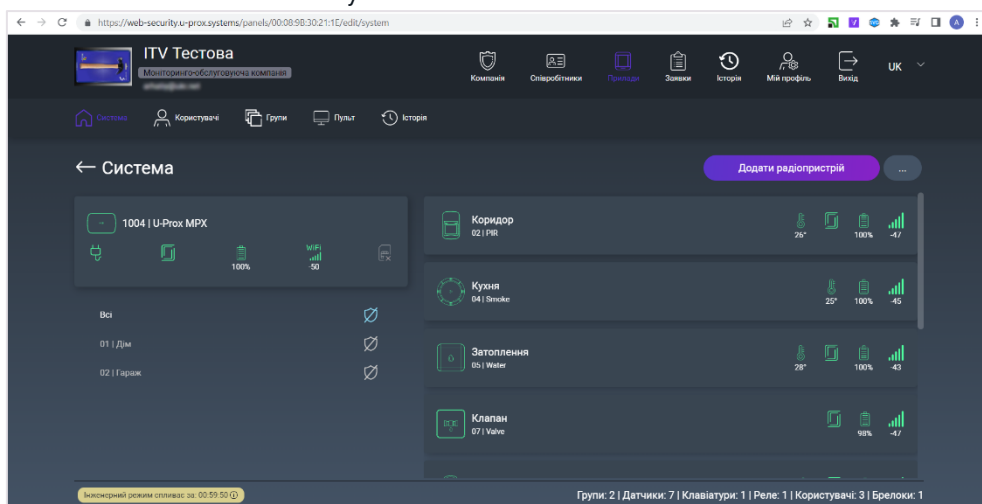

3. Select a device from the list

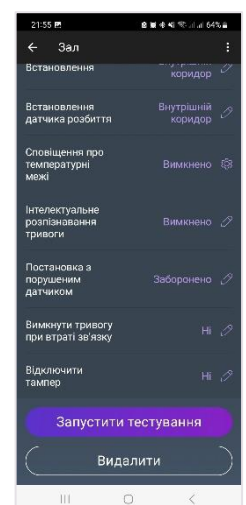
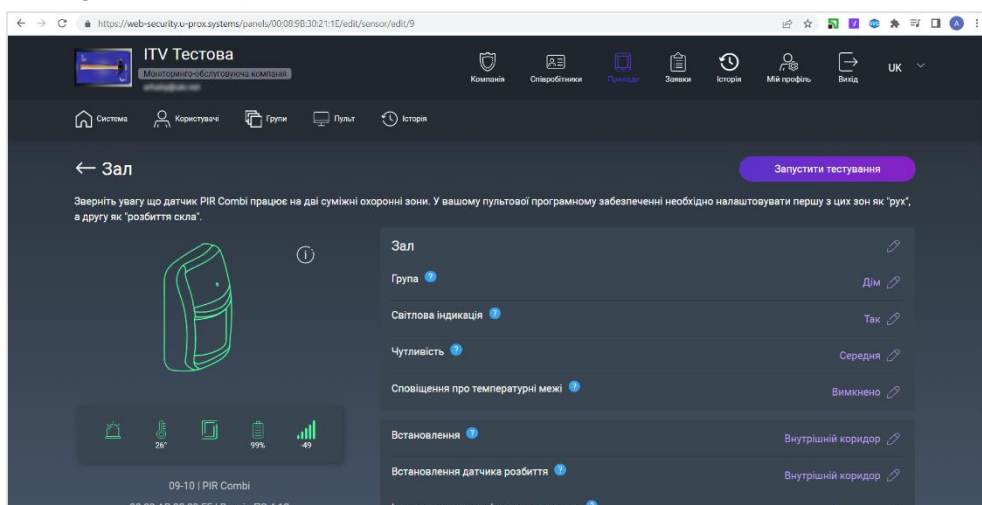

4. Start the test mode and select a mode - trigger test, normal signal test, Grade II signal test

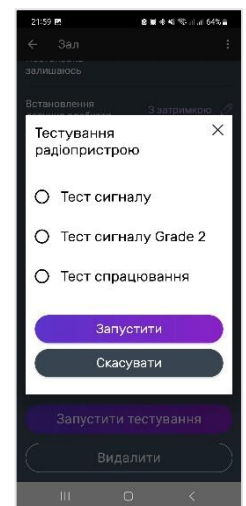
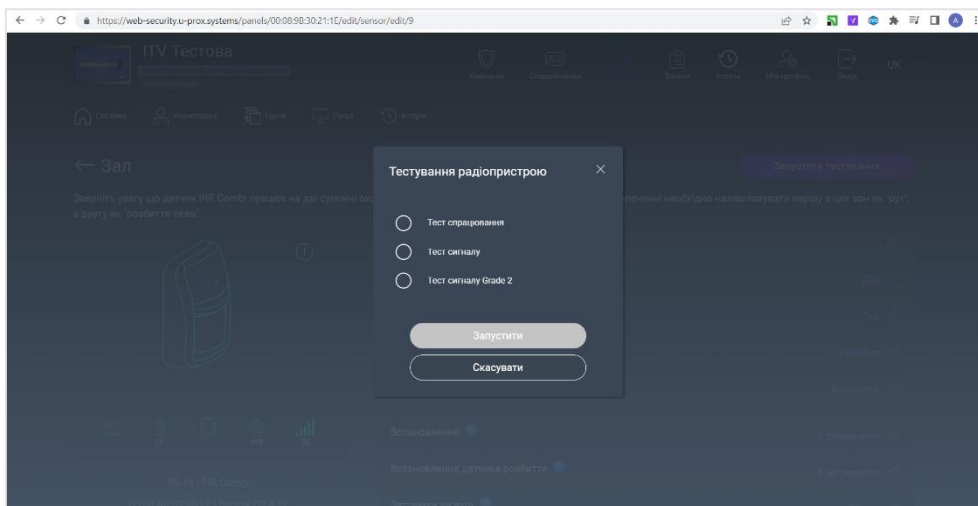

a. Trigger test - checking the operation of the motion sensor

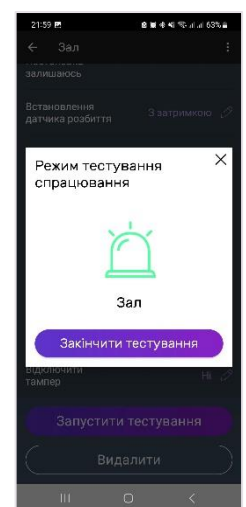
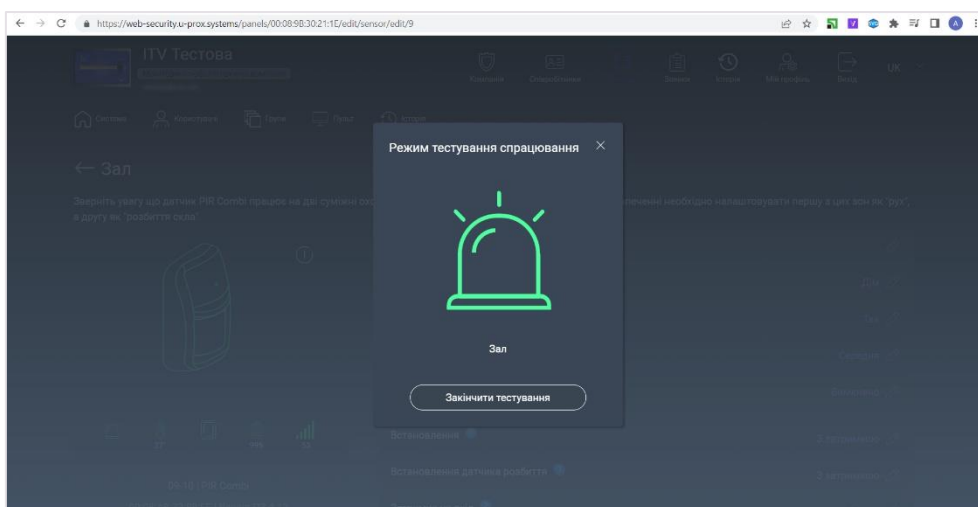

b. Conventional signal testing

ATTENTION!!! TESTING IS PERFORMED AT AN AVERAGE POWER LEVEL OF RADIO TRANSMITTERS.

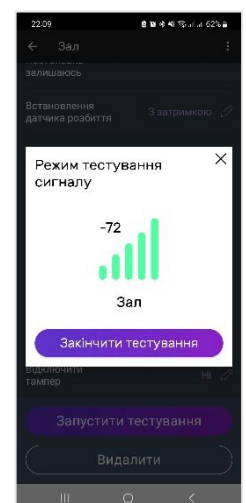
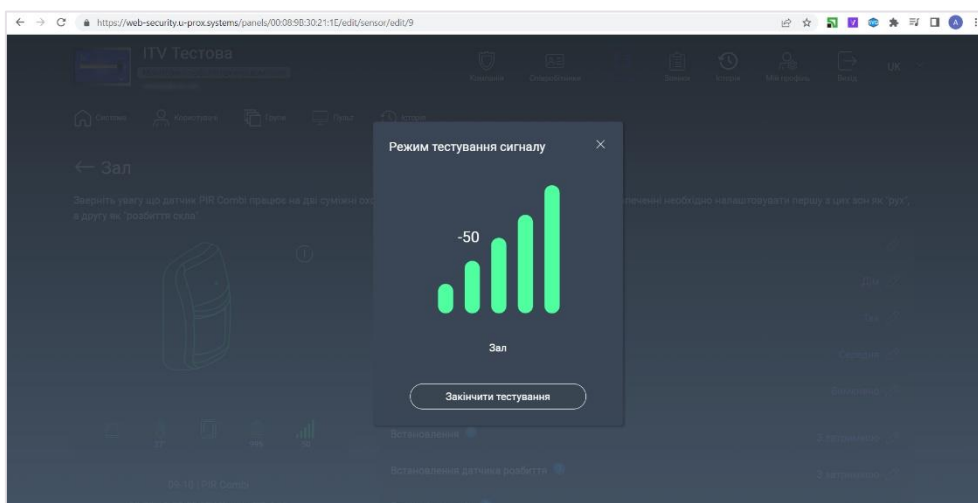

c. Signal testing in accordance with Grade II

ATTENTION!!! TESTING IS PERFORMED AT REDUCED POWER OF RADIO TRANSMITTERS, IN ACCORDANCE WITH EN 50131-1

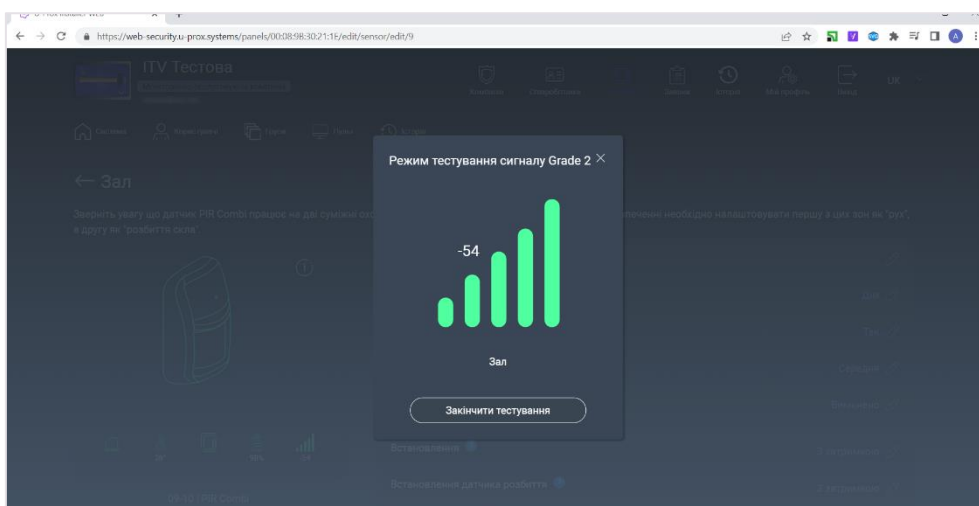

- To start testing the signal strength of the device, wait for the next communication session with the device, or trigger it, or remove its backplate.

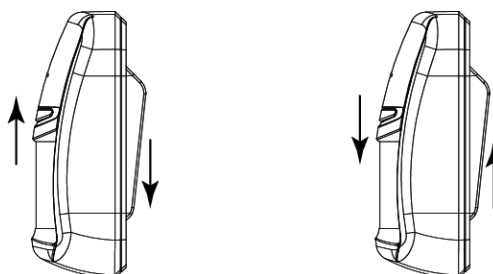

- Move the device to the pre-selected installation location

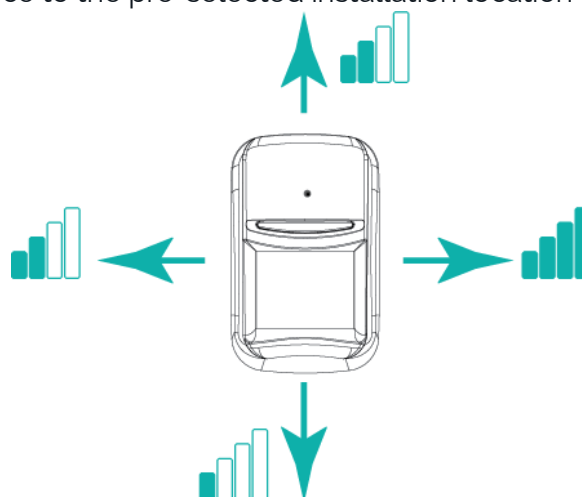

- Based on the data in the U-Prox Installer or U-Prox Installer WEB mobile application, select a location with an optimal signal strength of at least -95 dBm.

- You can also use the light indication of the device

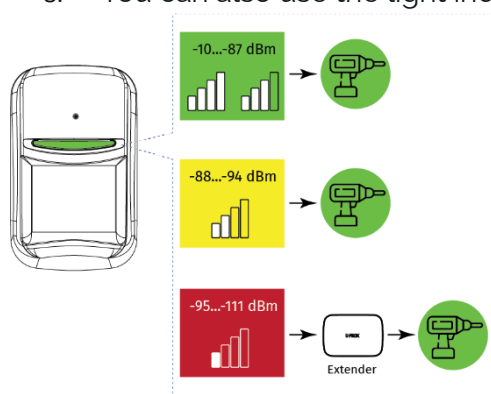

- LED flashes green (up to -87 dBm) - excellent signal strength, can be set
- LED flashes yellow (up to -88 ... -94 dBm) - average signal strength, can be set
- LED flashes red (up to -95 ... -111 dBm) - poor signal strength, move the device to another

location or use the UProx Extender radio range extender

- To exit the signal test mode, click the "End Test" button in the application

ATTENTION!!! THE TEST WILL BE AUTOMATICALLY COMPLETED 30 MINUTES AFTER THE START

Remove a device

- Launch the U-Prox Installer application or log in to the U-Prox Installer WEB portal

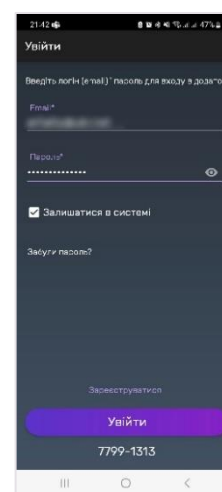
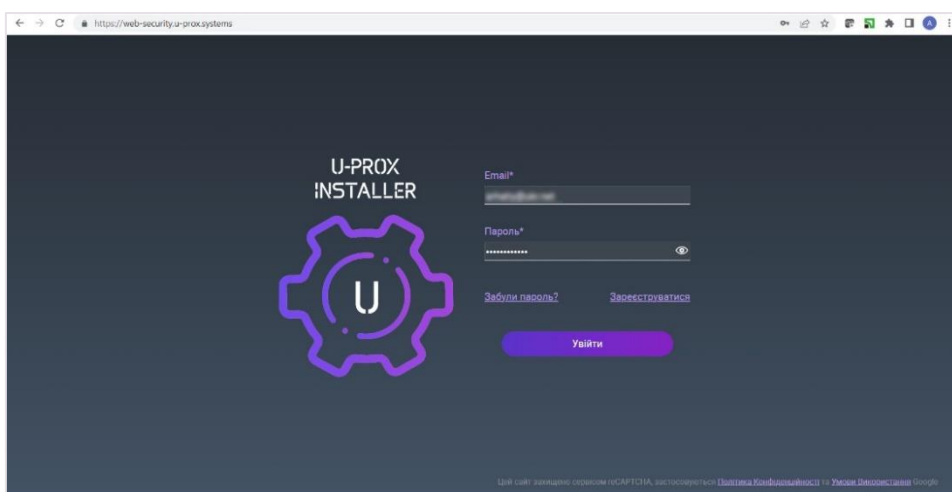

- Select a security center from the list

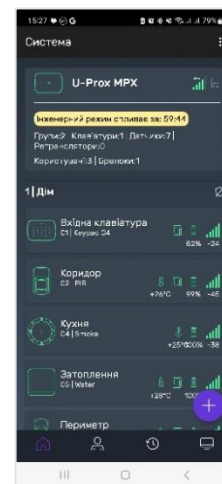
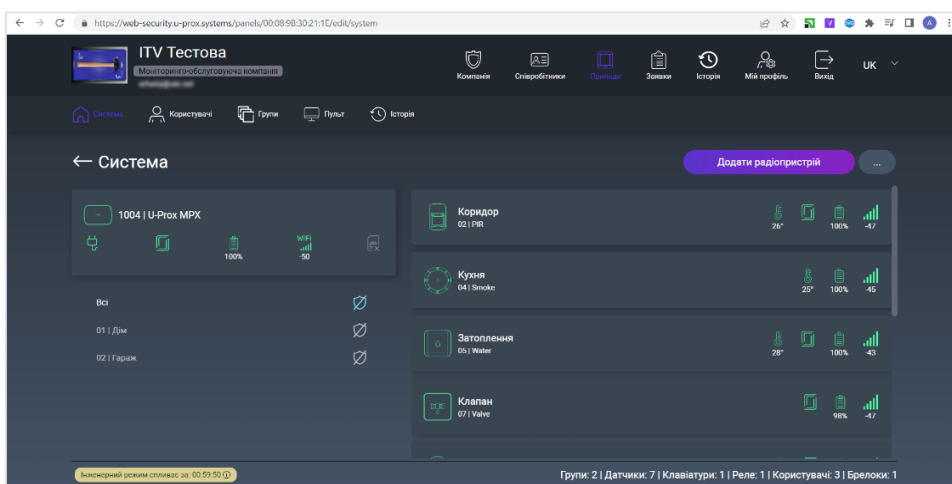



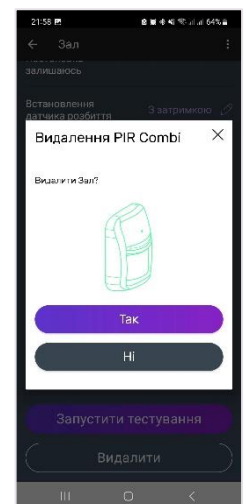
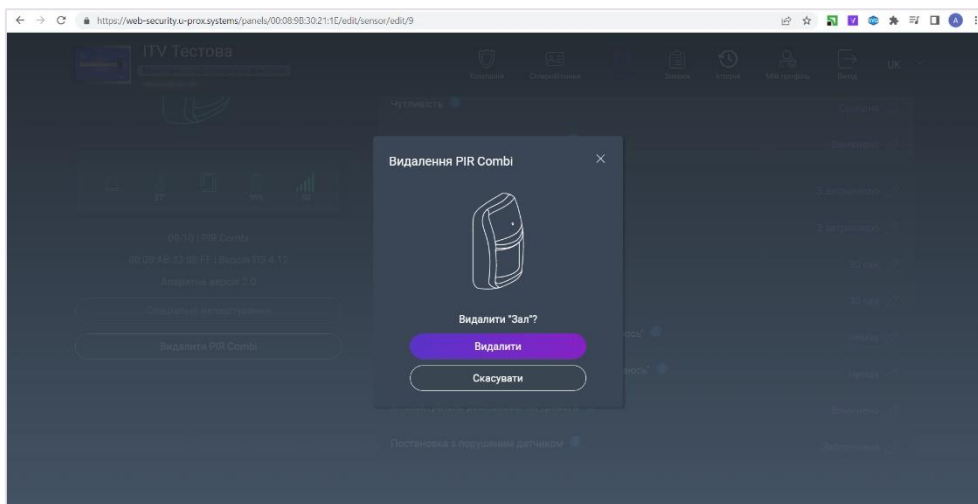



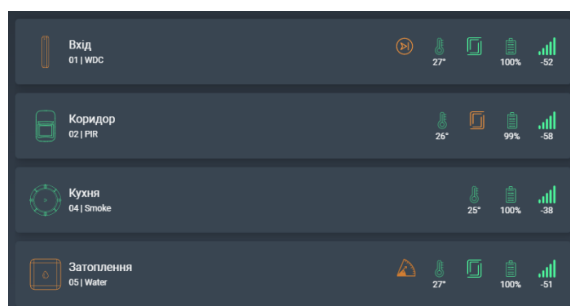



- Select the device from the list, click the "Uninstall" button, and confirm the removal



Wireless device states



-  - the main power supply is normal
-  - main power supply is absent
-  - the device case is closed
-  - the device case is open
-  - the battery is charged
-  - battery charge level
-  - the battery is critically low
-  - the battery is defective
-  - level of radio communication with the security center
-  - there is no radio communication with the security center
-  - passage (bypass) of the zone for the period of protection

Service

The device normally requires minimal maintenance.

Use a dry cloth suitable for appliances to periodically clean the device case from dust and other contaminants as they appear.

Replacing the battery

1. Remove the device from the backplate by sliding it upward.
2. Unscrew and remove the rear housing cover (6)
3. Replace the battery and reassemble the device
4. Dispose of used batteries in accordance with local laws and regulations.

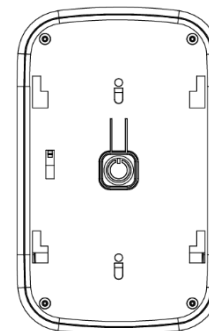

Compliance with standards

- RED (Radio Equipment Directive) Directive 2014/53/EU
- EU ROHS Directive 2011/65/EU, EN IEC 63000:2018
- EN 62311:2008
- EN 62368-1:2014
- EN 50130-4:2011/A1:2014
- EN 61000-6-3:2007/A1:2011
- ETSI EN 301 489-1 v2.2.3
- ETSI EN 301 489-3 v2.1.1
- ETSI EN 300 220-1 v3.1.1
- ETSI EN 300 220-2 v3.2.1
- EN 50131-1 Grade 2, Class II:
 - EN 50131-1:2006/A1:2009/A2:2017/A3:2020
 - EN 50131-2-2:2017
 - EN 50131-2-7-1:2012
 - EN 50131-5-3:2017
 - EN 50131-6:2017

Warranty obligations

The warranty period for the U-Prox device (excluding batteries) is 2 years from the date of sale.

If the device is not functioning properly, first contact support@uprox.systems, perhaps this issue will be resolved remotely.

The scope of delivery

1. U-Prox PIR Combi;
2. CR123A battery (pre-installed);
3. Backplate for the wall;
4. Corner backplate;
5. Installation kit;
6. Quick start guide